

Q.LIGN T-SERIE

WHEEL ALIGNMENT FULL THROTTLE:
MEASUREMENT AT THE HIGHEST LEVEL



FROM THE MAKERS
OF Q.LIGN



Q.Lign T-Series: Full concentration on wheel alignment

Q.Lign T-Series: The new productivity

Building on the success of Q.Lign, the T-Series complements the Beissbarth portfolio as a stand-alone solution in front of the vehicle, enabling workshops to exploit their full wheel alignment potential.

The integration of the complete measuring technology into the camera beam is unique, as is the large vertical field of view resulting from four precision cameras. This allows the Q.Lign T series to see and measure everything from a single fixed position - without moving or tilting the cameras.

The column is purely optional. Depending on the space available, workshops can choose between the space-saving wall installation and the classic solution in front of the vehicle.



Camera beam with two cameras on each side

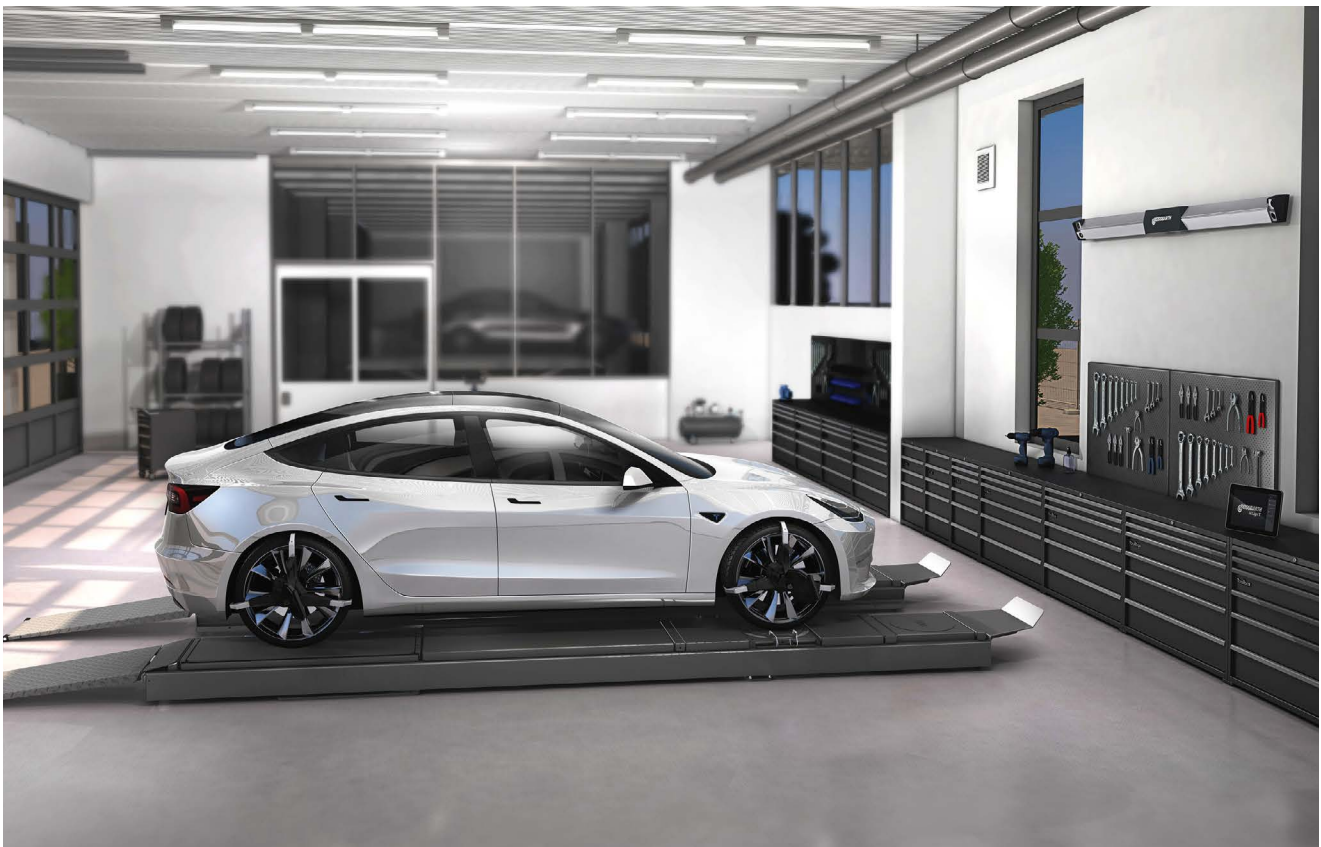

More space in the workshop: The technology for wheel alignment is fully integrated into the camera beam

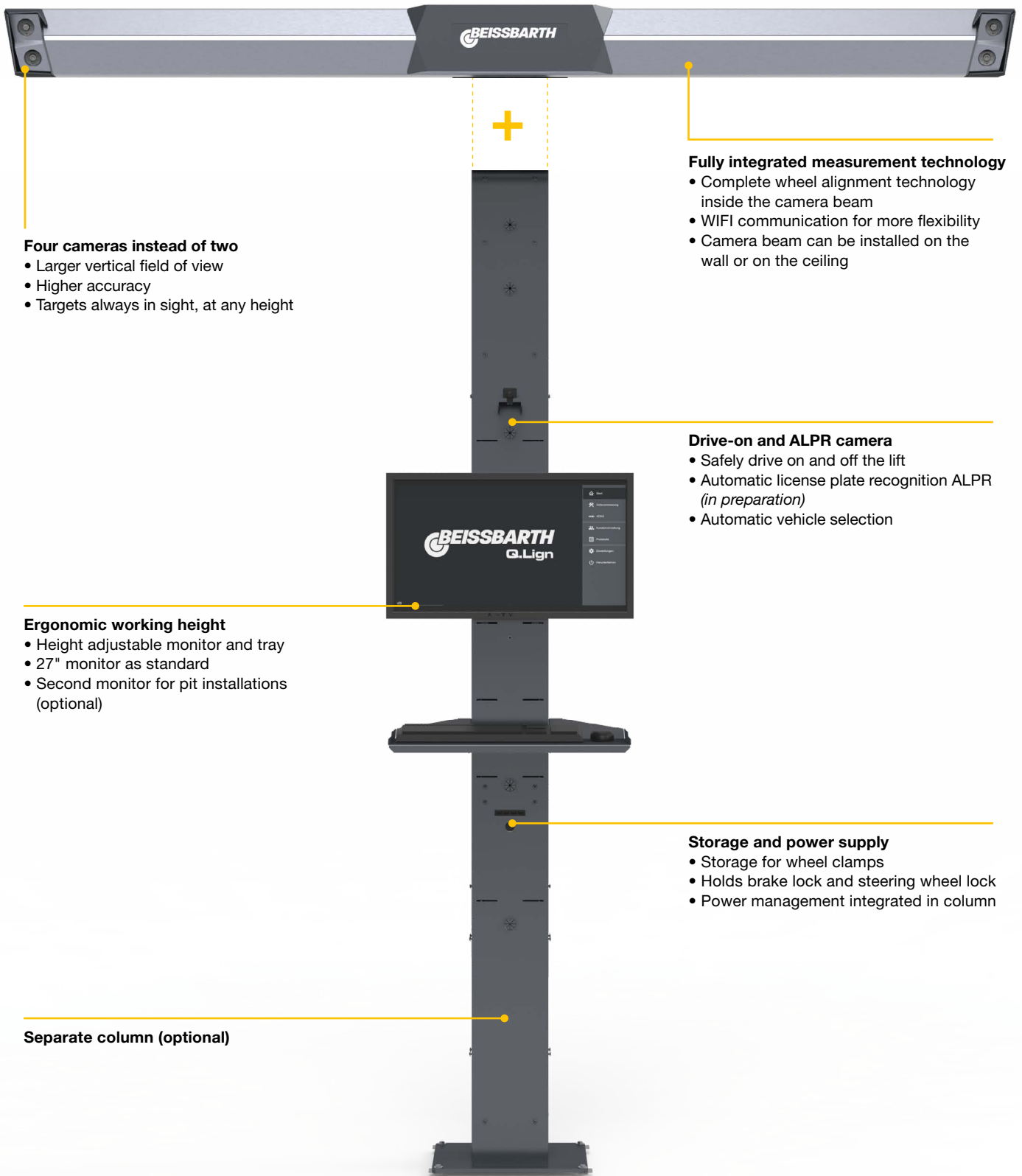

Four cameras instead of two

- Larger vertical field of view
- Higher accuracy
- Targets always in sight, at any height

Fully integrated measurement technology

- Complete wheel alignment technology inside the camera beam
- WIFI communication for more flexibility
- Camera beam can be installed on the wall or on the ceiling

Drive-on and ALPR camera

- Safely drive on and off the lift
- Automatic license plate recognition ALPR (*in preparation*)
- Automatic vehicle selection

Ergonomic working height

- Height adjustable monitor and tray
- 27" monitor as standard
- Second monitor for pit installations (optional)

Storage and power supply

- Storage for wheel clamps
- Holds brake lock and steering wheel lock
- Power management integrated in column

Separate column (optional)

Q.Lign T-Series: Productivity redefined

Q.Lign T-Series: Get the full picture

The four cameras powering Q.Lign detect all four wheels from a single position. At a distance from 1.8 to 3.3m to the front axle, both short and long wheelbase can be measured, without any height adjustment of the cameras.

Wide-angle camera for greater vertical field of view:

- Eliminates the need to move cameras and camera beams
- Perform runout compensation and caster sweep at ground level
- One camera per wheel for greater precision

Camera with focus on the rear axle:

- For wheelbases up to 5 000 mm
- Camera optimized for long range
- Tracks the rear axle during the entire alignment

DID YOU KNOW?

The rear axle determines the front toe values. The more accurately the rear axle is measured, the more precise the front axle measurement. That is why all Q.Lign wheel aligners have separate cameras for the front and rear axle.

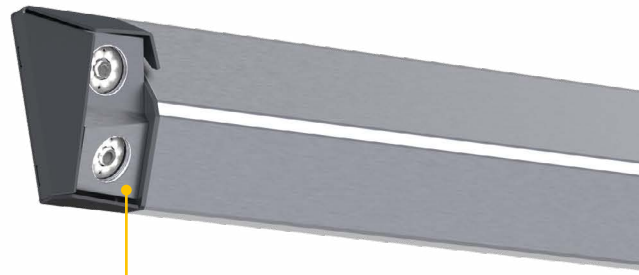

No moving parts, no hazards:

- Static camera beams eliminate equipment damage and technician hazards that could result from lowering the camera beam
- Performing runout compensation and caster sweep at floor level instead of mid-air eliminates the risk of injury for technicians

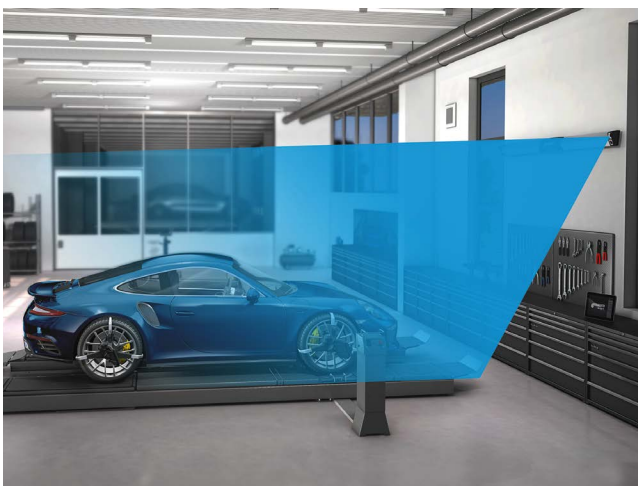

Q.Lign T-Series: Alignment at zero position

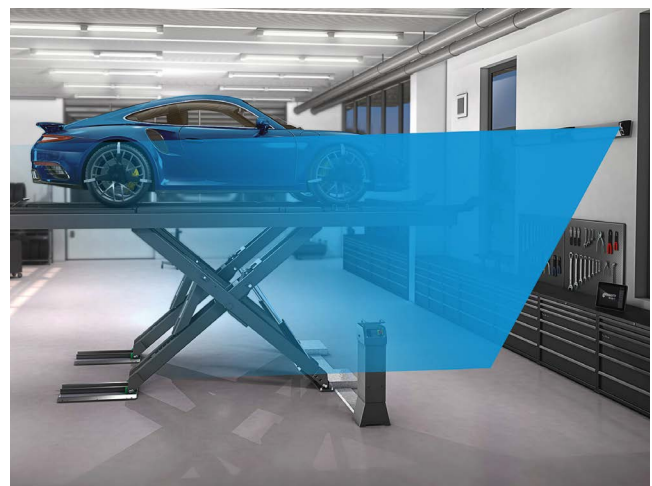

Q.Lign T-Series: Alignment at highest level



BEISSBARTH

Beissbarth MEMS technology for highest reliability

- Automatic compensation of unlevelled floors and movements
- Guaranteed highest measurement accuracy
- Repeatable results
- Measurements on any lift at any height

DID YOU KNOW?

Beissbarth wheel aligners with MEMS technology use the earth's gravity as a measurement reference. This eliminates the need for constant calibration to individual lift positions and adjustments can be made at any height.

 **M BB 1899**

Integrated camera with automatic license plate recognition ALPR when driving onto the lift
(in preparation, optional accessory)

- Automatic license plate recognition
- Automatic selection of returning customer vehicles
- Automatic customer and specs selection from license plate history

Q.Grip:

Fast mounting without rim contact



Q.Grip: Fast mounting without contact to the rim



Q.Grip: Strong and secure hold

Q.Grip for faster wheel alignments

The new Q.Grip clamps are mounted five times faster than conventional clamps. No need to remove hubcaps or special adapters, because Q.Grips grab the tire – without any contact to the rim.

- Mounted in seconds without rim contact
- Reduces clamping errors
- Automatic centering on wheel
- Quickly change between different wheel diameters without knob-twisting

Q.Lign: New generation targets



Scanning the QR code saves the calibration parameters of the targets

- Quick and easy installation
- No calibration tool required
- Faster service of customers



Stored targets are automatically identified during alignment

- Mounting of targets on any wheel
- Fast setup
- Eliminates user errors

Q.Lign T-Series: Power Management

Q.Lign T-Series with intelligent power supply

The power supply of the T-Series is fully integrated into the column and can be used anywhere in the world. Due to the intelligent power management system and low power consumption, measurements are possible even with fluctuating power supply. This ensures the continuous functionality of the T-Series.

- One solution for all countries: 110–260 V, 50–60 Hz
- Minimal power consumption
- Complies with UL standards

DID YOU KNOW?

Q.Lign's electronic architecture keeps energy consumption to a minimum and saves up to 96 % power compared to conventional PC-based wheel aligners.

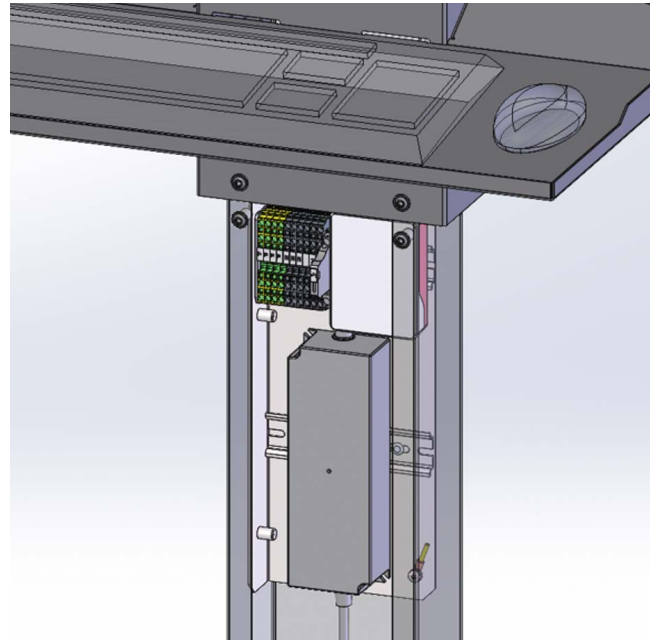

T-Series: Intelligent power supply module

Web-based wheel alignment: Simply more productive

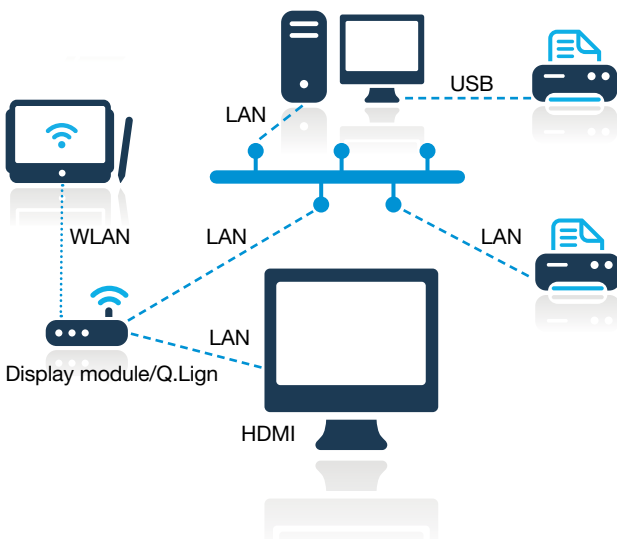

More productivity through connectivity

- Optimize workflows and maximize productivity by connecting Q.Lign to the workshop network
- Direct access from any device to all measurements across the shop floor network
- Usage of network printers reduces walking distances and costs
- Perform alignments with any browser-based device – no installation or additional hardware required
- Entering customer data or individual vehicle specifications conveniently from the workshop office

Q.Lign: Seamlessly integrates in your workshop network

Q.Lign software: Powerful and user-friendly

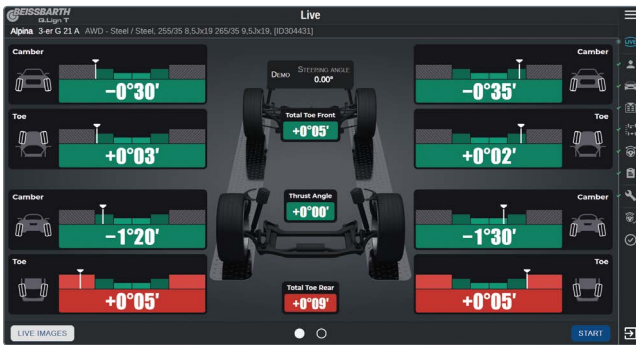

Clear and intuitive results display with live values

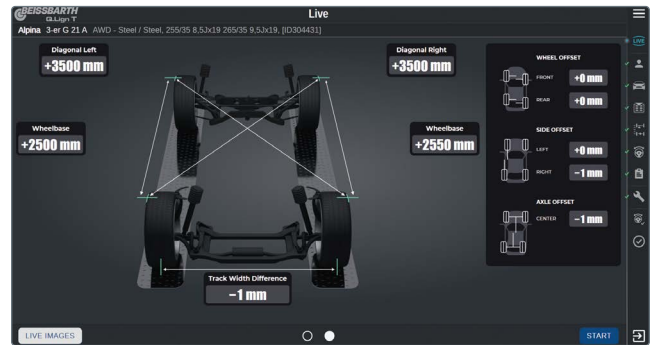

Cross-diagonal measurements to determine accident damages

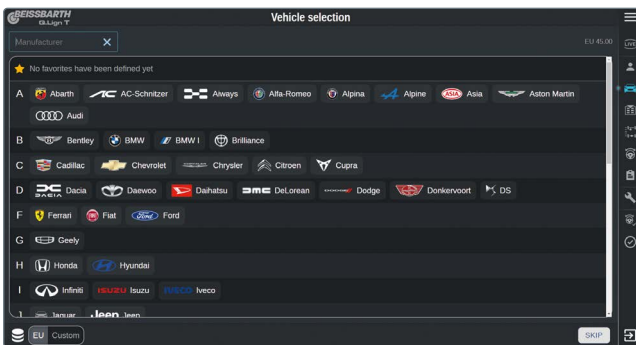

Quick vehicle selection from database including all manufacturers

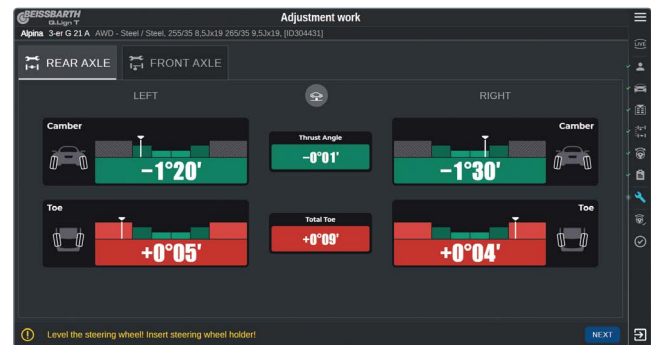

Intuitive alignment screens for quicker service



Results can be displayed with any device inside the same network

Q.Lign software for the T-Series

Since its market launch, Q.Lign's innovative wheel alignment software has proven itself especially through its fast and intuitive workflow. The T-Series uses the Q.Lign software platform with all its core features to perform high-quality wheel alignments.

- Simple, intuitive workflows guide technicians of all skill levels through the entire alignment process.
- Functions and measurement values are presented in user-friendly menus that are logical and easy to understand.

DID YOU KNOW?

Q.Lign is the only platform-independent wheel aligner. Any tablet, smartphone or PC/laptop can be used without the need for additional hardware or software.

Q.Lign T-Series: Documentation made simple



Beissbarth Automotive Testing Solutions GmbH
 Hanauer Str. 101
 80993 München
 +49 89 14901 233
 www.beissbarth.com
 sales@beissbarth.com

2023-07-03
15:28

Order number: 1001899

CUSTOMER AND VEHICLE

Mileage: 14905



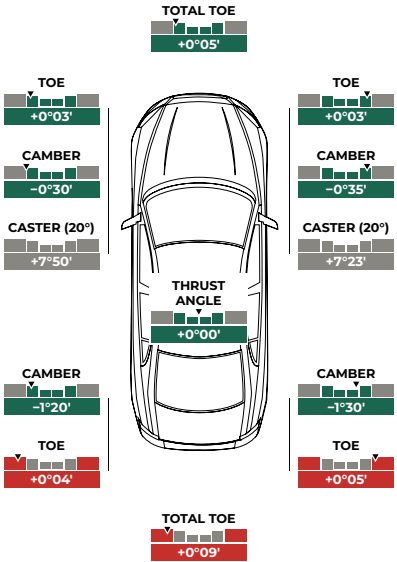

Alpina 3-er G 21 A
 AWD - Steel / Steel, 255/35
 8,5Jx19 265/35 9,5Jx19, [1D304431]

ALIGNMENT CHECK

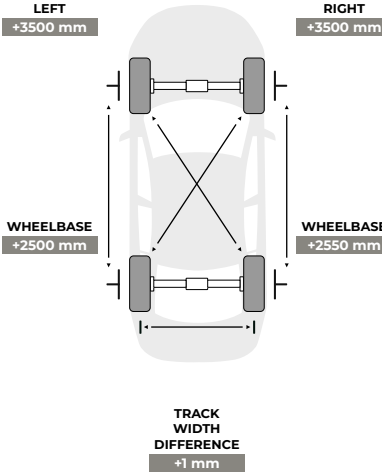

BODY DIMENSIONS CHECK



WHEEL SETBACK		SIDE OFFSET		AXLE OFFSET		
	FRONT	-1 mm		LEFT	+0 mm	
	REAR	+0 mm		RIGHT	+0 mm	
					CENTER	+0 mm
BEFORE ADJUSTMENT						

Runout compensation has been performed



dev2021B-150-gc636cfd32, Beissbarth EU 45.00

Printout

Measurement results – clearly and quickly documented

- Intuitive, informative printout
- Share printouts with insurance companies and customers directly as PDF

The right solution for every workshop

Q.Lign T-Series

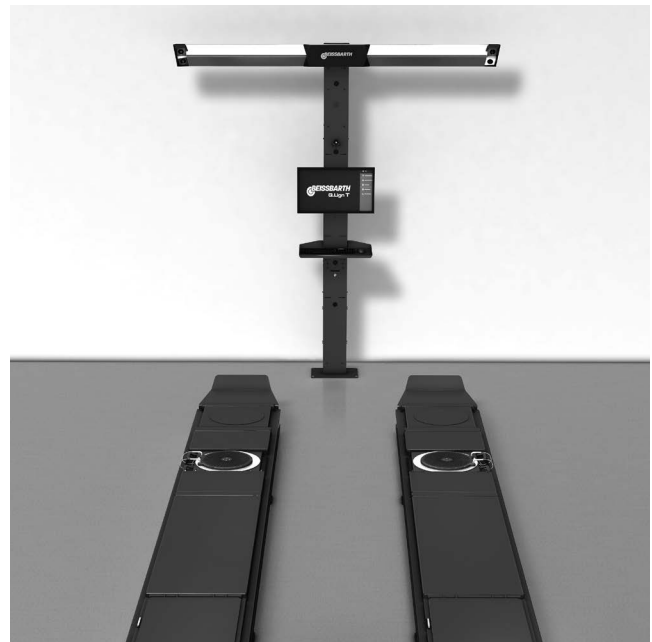
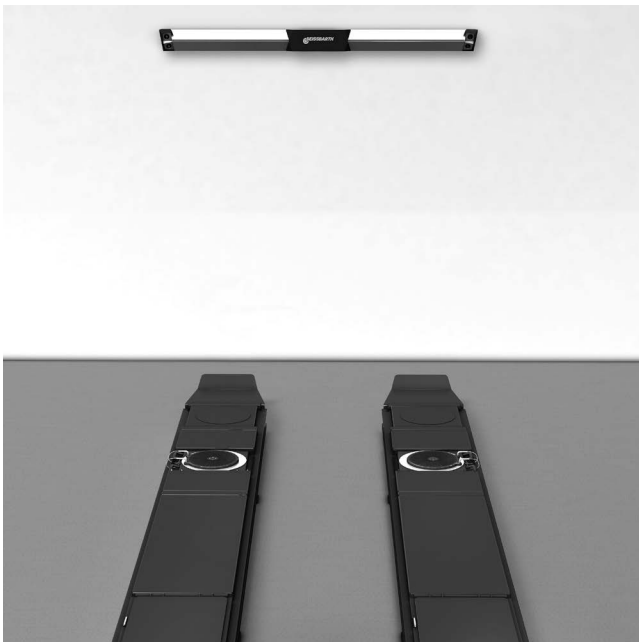

Q.Lign T.41 Kit wall installation

- Full integration into the workshop – no need for columns or trolleys
- Fixed installation of the camera beam on the wall
- 360° access to the lift
- Optimal for multi-use service bays, e.g. opposite a workbench

Q.Lign T.41 column/floor installation

- Fixed installation on a column
- Free access to the lift
- Fixed installation in front of the vehicle
- Available with Multifit or Q.Grip wheel clamps



Depending on workshop preferences: Q.Lign T series available as floor or wall installation

Scope of delivery and accessories

Q.Lign T-Series

Scope of delivery:

Q.Lign T-Series	T.41 Kit 1 690 800 000	T.41 1 690 800 001	T.41 Q.Grip 1 690 800 002
Type of installation	Wall	Floor	Floor
Column with tray	-	•	•
Accessories			
Targets	•	•	•
Brake lock	•	•	•
Steering wheel lock	•	•	•
Wheel clamps	optional	Multifit	Q.Grip
Holder for wheel clamps	optional	•	•
Monitor 27"	optional	•	•
Keyboard and mouse	optional	•	•
Tablet	•	optional	optional
Turntable with fillers	optional	•	•
ALPR camera (Automatic License Plate Recognition)	optional	optional	optional
Additional monitor for pits	optional	optional	optional
Printer	optional	optional	optional



Q.Grip Clamps 4 pcs.
Order number: 1 690 101 010



Magnetic clamps 4pcs.
Order number: 1 690 701 508



Multifit clamps 4pcs.
Order number: 1 690 311 112



Truck claws for Multifit clamp
Order number: 1 690 311 115



28'' extensions for Multifit clamp
Order number: 1 690 311 113



Turntable
Order number: 1 690 501 001



Q.Lign tablet, Android 10.1" (incl. cover)
Order number: 1 693 770 644



Filler
Order number: 1 690 702 082



Trolley with 27'' monitor for Q.Lign
Order number: 1 690 201 055

Delivery, installation and maintenance: Made easy with Q.Lign T-Series

Delivery and installation were considered during the development of the Q.Lign T series. No matter which version the workshop chooses – the Q.Lign T-Series is the fastest way to quality wheel alignments.

sales@beissbarth.com

Space requirements

- A** Distance: min. 1,800 mm, max. 3,300 mm
- B** Column height: 2,745 mm
- C** Camera beam width: 2,595 mm
- D** Working height: 2,577 mm
- E** Distance to wall: min. 290 mm

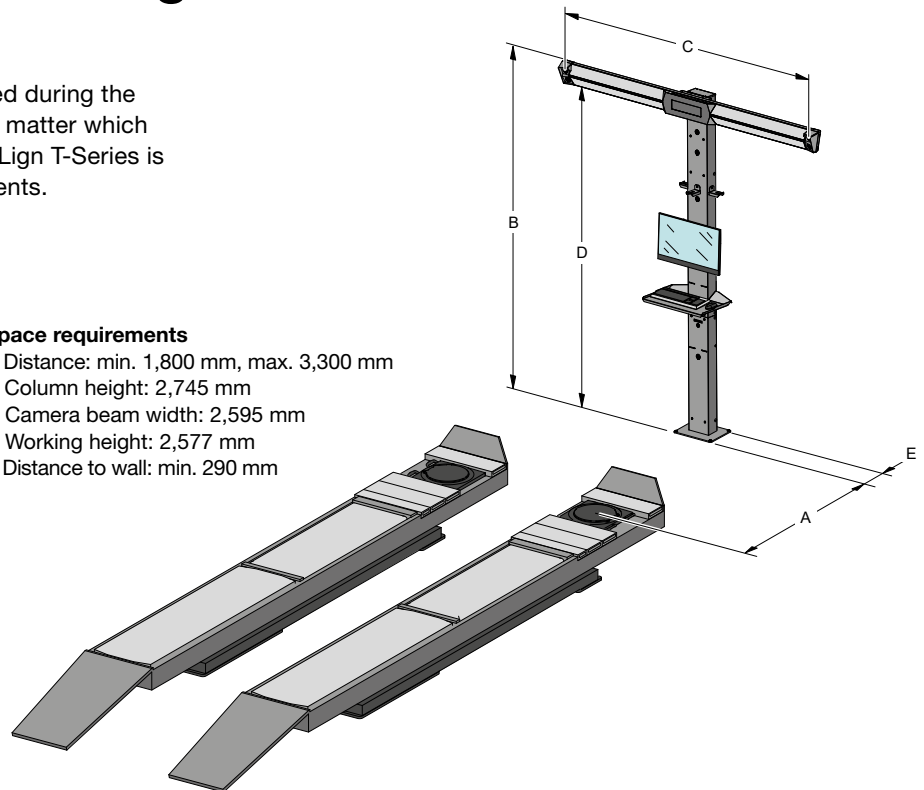

Technical data

Description	T.41 Kit	T.41	T.41 Q.Grip
Shipping dimensions (L x W x H)	280 x 25 x 35 cm	295 x 82 x 54 cm	295 x 82 x 54 cm
Shipping weight	29 kg	170 kg	170 kg
Wheelbase	1,800–5,000 mm/71–196"	1,800–5,000 mm/71–196"	1,800–5,000 mm/71–196"
Clamping range	Depending on wheel clamp	Multifit: rim diameter 13"–23" (optionally up to 28")	Q.Grip: wheel diameter 525 mm–840 mm/20,6"–33"
Track width	2,100 mm/82,6"	2,100 mm/82,6"	2,100 mm/82,6"
Adjustment heights	0–1,800 mm	0–1,800 mm	0–1,800 mm
Min. clearance between lift front posts	2,800 mm/110"	2,800 mm/110"	2,800 mm/110"
Power supply	110–260 V/50–60 Hz	110–260 V/50–60 Hz	110–260 V/50–60 Hz
Power consumption	45 W	65 W	65 W
Factory-calibrated	●	●	●

Beissbarth Automotive Testing Solutions GmbH

Hanauer Str. 101 · 80993 Munich

Germany

sales@beissbarth.com